

## SIRIUS HRI

High pressure discharge lamps designed to provide brilliant light effects.



### Области применения

- Концертное освещение
- Ночные клубы и дискотеки
- Сцена и театр
- Студийная, теле- и киносъемка
- Объекты архитектуры и индустрии развлечений

### Характеристики продукта

- Lightweight and compact reflector lamps with ECG
- High luminance through very short arc and high pressure
- Produces brilliant light effects
- Stable light output over the entire lifetime
- Long lifetime
- Easy lamp replacement
- Approved by leading moving lighting fixture companies



## Данные о продуктовой линейке

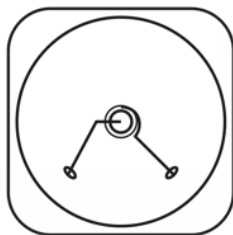
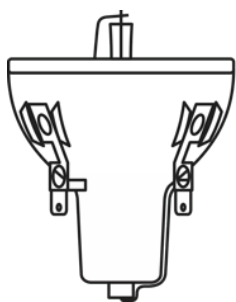

SIRIUS HRI 100W

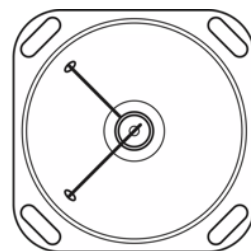
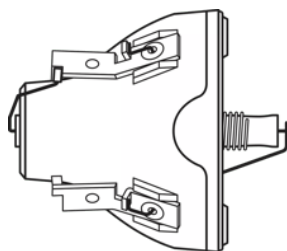

SIRIUS HRI 132W

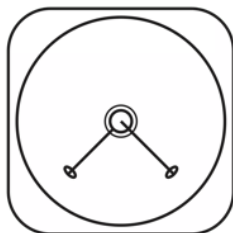
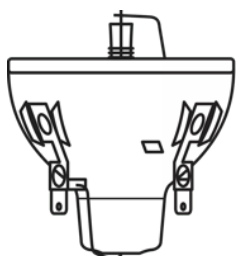

SIRIUS HRI 132W

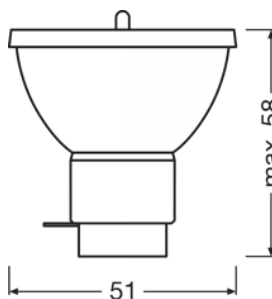

SIRIUS HRI 251W

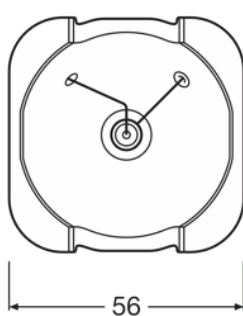
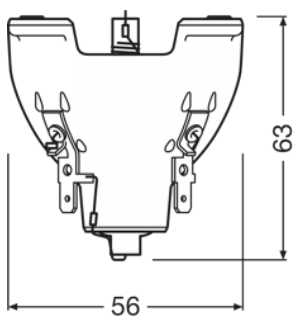

SIRIUS HRI 330W

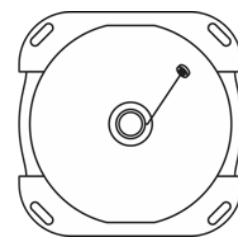
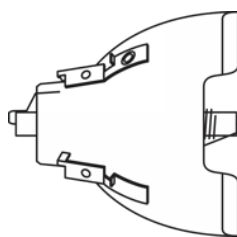

SIRIUS HRI 330W

## Данные о продуктовой линейке

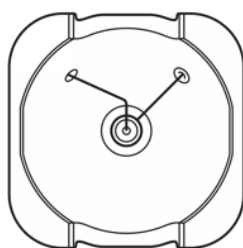
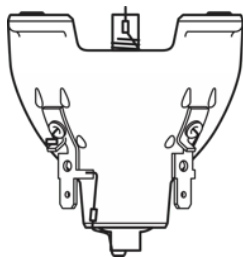

SIRIUS HRI 330W

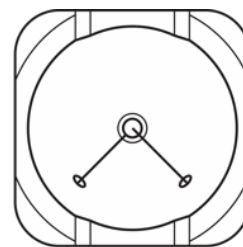
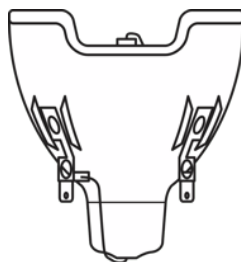

SIRIUS HRI 330W X8

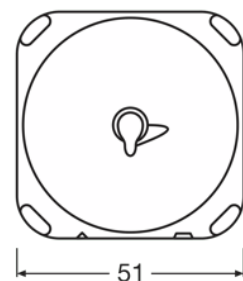
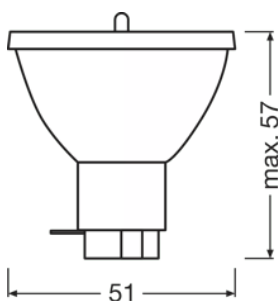

SIRIUS HRI 295 W

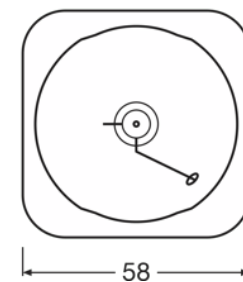
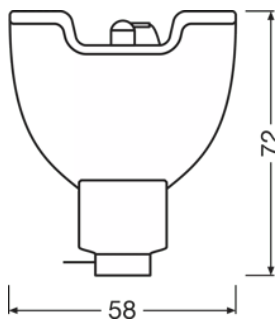

SIRIUS HRI 371W

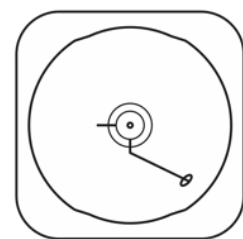
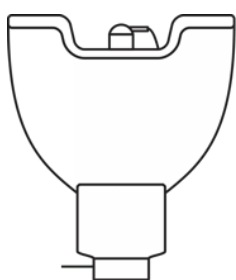

SIRIUS HRI 371W

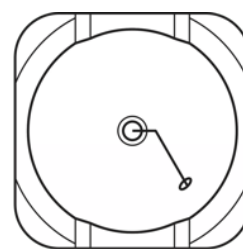
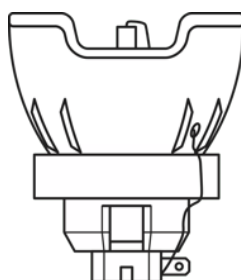

SIRIUS HRI 440W

## Данные о продуктовой линейке

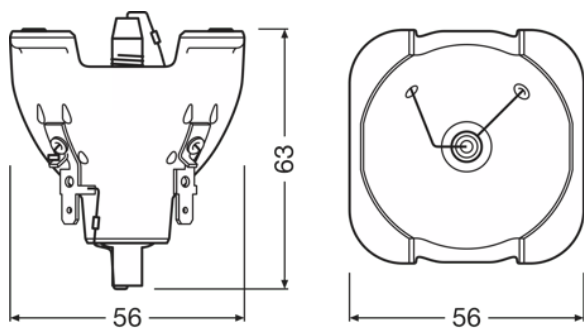

Sirius HRI 330W XL

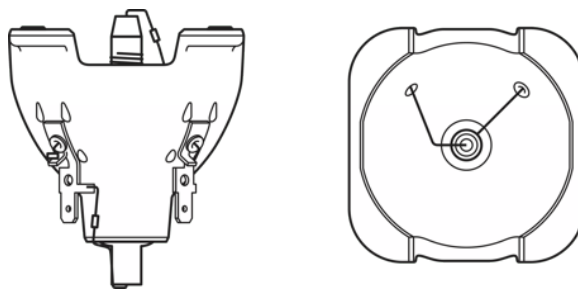

Sirius HRI 330W XL

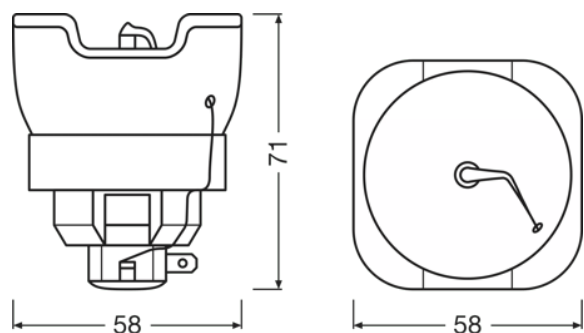

SIRIUS HRI 580 F

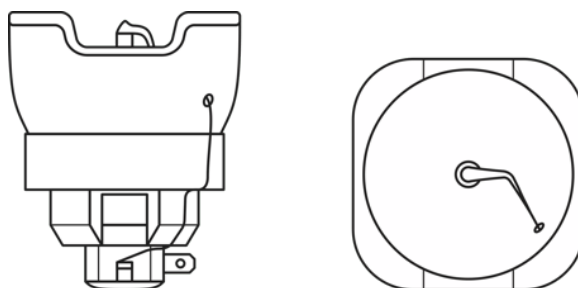

SIRIUS HRI 580 F

## Данные о продуктовой линейке

### Technical data

Описание продукта	General Product Information	Электрические параметры	Фотометрические данные	
	Category	Номинальная мощность	Световой поток	Working distance
SIRIUS HRI 100 W	CORE	100 W	3680 lm	30 mm
SIRIUS HRI 132 W SC	CORE	132 W	5150 lm	37.7 mm
SIRIUS HRI 140 W RO	CUSTOMIZED	140 W	5400 lm	37.7 mm
SIRIUS HRI 190 W+	CORE	190 W	8100 lm	34.5 mm
SIRIUS HRI 230 W	CORE	230 W	9500 lm	34.5 mm
SIRIUS HRI 231 W	VALUE	231 W	10800 lm	34.5 mm
SIRIUS HRI 280 W	CORE	280 W	11500 lm	34.5 mm
SIRIUS HRI 251 W	VALUE	251 W	12000 lm	38 mm
SIRIUS HRI 281 W	VALUE	281 W	13000 lm	34.5 mm
SIRIUS HRI 260 W PRO	PRO	260 W	13500 lm	34.5 mm
SIRIUS HRI 330 W	CORE	330 W	18000 lm	31 mm
SIRIUS HRI 280 W RO	CUSTOMIZED	280 W	11500 lm	34.5 mm
SIRIUS HRI 330 W X8	CUSTOMIZED	330 W	18000 lm	37.4 mm
SIRIUS HRI 371 W +	CORE	370 W	18300 lm	37.4 mm
SIRIUS HRI 295 W	CORE	295 W	11300 lm	34.5 mm
SIRIUS HRI 310 W	CORE	310 W	15000 lm	36.5 mm
SIRIUS HRI 310 W RO	CUSTOMIZED	310 W	13500 lm	48 mm
HRI 371 W S +	CORE	371 W	19800 lm	31.4 mm
SIRIUS HRI 371 W	VALUE	371 W	18300 lm	31.4 mm
SIRIUS HRI 310 W PRO	PRO	310 W	15500 lm	37.4 mm
SIRIUS HRI 371 W S	VALUE	371 W	19800 lm	37.4 mm
SIRIUS HRI 310 W S PRO	PRO	310 W	15500 lm	31.4 mm
SIRIUS HRI 440 W	CORE	440 W	22000 lm	41 mm
SIRIUS HRI 311 W	VALUE	311 W	14500 lm	31.4 mm
SIRIUS HRI 440 W H	CUSTOMIZED	440 W	18000 lm	60 mm
SIRIUS HRI 330 W XL	CORE	330 W	16500 lm	36 mm
SIRIUS HRI 471 W SN	VALUE	471 W	20000 lm	41 mm
SIRIUS HRI 550 W XL	CORE	550 W	28000 lm	59 mm
SIRIUS HRI 381 W S	CUSTOMIZED	381 W	20000 lm	34.4 mm
SIRIUS HRI 380 W Pro	PRO	380 W	20000 lm	31.4 mm
SIRIUS HRI 380 W S PRO	PRO	380 W	20000 lm	31.4 mm
SIRIUS HRI 382 W	CORE	382 W	21000 lm	37.4 mm
SIRIUS HRI 382 W S	CORE	382 W	20000 lm	31.4 mm
SIRIUS HRI 420 W	CORE	420 W	22000 lm	34.4 mm
SIRIUS HRI 420 W S	CORE	420 W	21000 lm	34.4 mm
SIRIUS HRI 440 W +	CORE	440 W	22800 lm	41 mm
SIRIUS HRI 440 W S	CORE	440 W	22800 lm	37.4 mm
SIRIUS HRI 440 W X	CUSTOMIZED	440 W	22800 lm	41 mm
SIRIUS HRI 461 W	VALUE	461 W	24000 lm	41 mm
SIRIUS HRI 461 W S	VALUE	461 W	24000 lm	37.4 mm
SIRIUS HRI 462 W	CORE	462 W	24000 lm	41 mm

## Данные о продуктовой линейке

Описание продукта	General Product Information	Электрические параметры	Фотометрические данные	
	Category	Номинальная мощность	Световой поток	Working distance
SIRIUS HRI 470 W	CORE	470 W	20500 lm	41 mm
SIRIUS HRI 470 W S	CORE	470 W	21500 lm	37.4 mm
SIRIUS HRI 470 W RO	CUSTOMIZED	470 W	19500 lm	48 mm
SIRIUS HRI 470 W XL	CORE	470 W	24000 lm	59 mm
SIRIUS HRI 550 W	CORE	550 W	28000 lm	41 mm
HRI 580 W F	CUSTOMIZED	580 W	29500 lm	60 mm

Описание продукта	Physical Attributes & Dimensions			
	Расстояние между электродами (холод)	Цоколь	Диаметр	Длина
SIRIUS HRI 100 W	1,0 mm	SPEZIAL	45.0 mm	53.0 mm
SIRIUS HRI 132 W SC	1,0 mm	-	46.0 mm	max. 44 mm
SIRIUS HRI 140 W RO	1,0 mm	-	46.0 mm	max. 44 mm
SIRIUS HRI 190 W+	-	-	51.0 mm	54.5 mm
SIRIUS HRI 230 W	1,0 mm	-	51.0 mm	54.5 mm
SIRIUS HRI 231 W	1,0 mm	-	51.0 mm	50.0 mm
SIRIUS HRI 280 W	0,9 mm	-	51.0 mm	54.5 mm
SIRIUS HRI 251 W	-	-	51.0 mm	61.0 mm
SIRIUS HRI 281 W	1,0 mm	-	51.0 mm	50.0 mm
SIRIUS HRI 260 W PRO	0,9 mm	-	51.0 mm	50.0 mm
SIRIUS HRI 330 W	1,0 mm	-	56.0 mm	63.0 mm
SIRIUS HRI 280 W RO	0,9 mm	-	51.0 mm	54.5 mm
SIRIUS HRI 330 W X8	1,0 mm	-	58.0 mm	66.0 mm
SIRIUS HRI 371 W +	1,2 mm	-	58.0 mm	72.0 mm
SIRIUS HRI 295 W	-	-	51.0 mm	53.5 mm
SIRIUS HRI 310 W	-	-	51.0 mm	53.5 mm
SIRIUS HRI 310 W RO	-	-	60.0 mm	67.0 mm
HRI 371 W S +	1,2 mm	-	58.0 mm	72.0 mm
SIRIUS HRI 371 W	1,0 mm	-	58.0 mm	72.0 mm
SIRIUS HRI 310 W PRO	0,9 mm	-	58.0 mm	72.0 mm
SIRIUS HRI 371 W S	1,2 mm	-	58.0 mm	72.0 mm
SIRIUS HRI 310 W S PRO	0,9 mm	-	58.0 mm	72.0 mm
SIRIUS HRI 440 W	1,3 mm	-	58.0 mm	71.0 mm
SIRIUS HRI 311 W	-	-	51.0 mm	50.0 mm
SIRIUS HRI 440 W H	1,3 mm	-	65.0 mm	60.0 mm
SIRIUS HRI 330 W XL	1,0 mm	-	56.0 mm	63.0 mm
SIRIUS HRI 471 W SN	1,3 mm	Side Prong	60.0 mm	67.0 mm
SIRIUS HRI 550 W XL	-	Side Prong	60.0 mm	67.0 mm
SIRIUS HRI 381 W S	-	-	58.0 mm	72.0 mm
SIRIUS HRI 380 W Pro	-	-	58.0 mm	72.0 mm
SIRIUS HRI 380 W S PRO	-	-	58.0 mm	72.0 mm
SIRIUS HRI 382 W	1,0 mm	-	58.0 mm	72.0 mm
SIRIUS HRI 382 W S	1,0 mm	-	58.0 mm	72.0 mm

## Данные о продуктовой линейке

Описание продукта	Physical Attributes & Dimensions			
	Расстояние между электродами (холод)	Цоколь	Диаметр	Длина
SIRIUS HRI 420 W		-	58.0 mm	72.0 mm
SIRIUS HRI 420 W S		-	58.0 mm	72.0 mm
SIRIUS HRI 440 W +		-	58.0 mm	71.0 mm
SIRIUS HRI 440 W S		-	11.8 mm	71.0 mm
SIRIUS HRI 440 W X	1,0 mm	-	58.0 mm	71.0 mm
SIRIUS HRI 461 W	1,3 mm	-	60.0 mm	67.0 mm
SIRIUS HRI 461 W S	1,3 mm	-	60.0 mm	67.0 mm
SIRIUS HRI 462 W		-	58.0 mm	72.0 mm
SIRIUS HRI 470 W	1,3 mm	-	58.0 mm	71.0 mm
SIRIUS HRI 470 W S	1,3 mm	-	58.0 mm	71.0 mm
SIRIUS HRI 470 W RO	1,2 mm	-	60.0 mm	67.0 mm
SIRIUS HRI 470 W XL	1,3 mm	-	60.0 mm	67.0 mm
SIRIUS HRI 550 W	1.5 mm	Side Prong	60.0 mm	67.0 mm
HRI 580 W F		-	65.0 mm	65.0 mm

Описание продукта	Вес продукта	Diameter (in)	Разъем: наличие [PICOS]	Температуры и условия управления
				Положение горения
SIRIUS HRI 100 W	60.00 g			Любой
SIRIUS HRI 132 W SC	60.00 g	1.810 in		Любой
SIRIUS HRI 140 W RO	60.00 g			Любой
SIRIUS HRI 190 W+	60.00 g			
SIRIUS HRI 230 W	60.00 g	2.008 in		Любой
SIRIUS HRI 231 W	60.00 g			Любой
SIRIUS HRI 280 W	60.00 g	2.008 in		Любой
SIRIUS HRI 251 W	50.00 g			
SIRIUS HRI 281 W	60.00 g			Любой
SIRIUS HRI 260 W PRO	60.00 g			
SIRIUS HRI 330 W	75.00 g	2.008 in		Любой
SIRIUS HRI 280 W RO	65.00 g			Любой
SIRIUS HRI 330 W X8	100.00 g	0.236 in		Любой
SIRIUS HRI 371 W +	130.00 g			
SIRIUS HRI 295 W	63.50 g			
SIRIUS HRI 310 W	60.00 g			
SIRIUS HRI 310 W RO	135.00 g			Любой
HRI 371 W S +	130.00 g			
SIRIUS HRI 371 W	130.00 g			Любой
SIRIUS HRI 310 W PRO	130.00 g			
SIRIUS HRI 371 W S	130.00 g			Любой
SIRIUS HRI 310 W S PRO	130.00 g			
SIRIUS HRI 440 W	100.00 g			Любой
SIRIUS HRI 311 W	60.00 g			

## Данные о продуктовой линейке

Описание продукта	Вес продукта	Diameter (in)	Разъем: наличие [PICOS]	Температуры и условия управления
				Положение горения
SIRIUS HRI 440 W H	160.00 g			Любой
SIRIUS HRI 330 W XL	75.00 g	0.512 in		Любой
SIRIUS HRI 471 W SN	140.00 g			Любой
SIRIUS HRI 550 W XL	140.00 g			
SIRIUS HRI 381 W S	130.00 g			
SIRIUS HRI 380 W Pro	130.00 g			
SIRIUS HRI 380 W S PRO	130.00 g			
SIRIUS HRI 382 W	136.00 g		Yes	
SIRIUS HRI 382 W S	136.00 g		Yes	
SIRIUS HRI 420 W	130.00 g			
SIRIUS HRI 420 W S	130.00 g			
SIRIUS HRI 440 W +	135.50 g			
SIRIUS HRI 440 W S	100.00 g			Любой
SIRIUS HRI 440 W X	135.50 g			
SIRIUS HRI 461 W	140.00 g			Любой
SIRIUS HRI 461 W S	140.00 g			Любой
SIRIUS HRI 462 W	130.00 g			
SIRIUS HRI 470 W	103.60 g			Любой
SIRIUS HRI 470 W S	103.60 g			Любой
SIRIUS HRI 470 W RO	140.00 g			Любой
SIRIUS HRI 470 W XL	140.00 g			Любой
SIRIUS HRI 550 W	140.00 g			
HRI 580 W F	160.00 g			

Описание продукта	Охлаждение	Срок службы	Нормативная и природоохранная информация Information according Art. 33 of EU Regulation (EC) 1907/2006 (REACH)	
		Average Rated Life	Основной идентификатор изделия	Номер декларации в базе данных SCIP
SIRIUS HRI 100 W	Усиленный	6000 hr	4052899329119   4052899321656	No declarable substances contained
SIRIUS HRI 132 W SC	Усиленный	6000 hr	4052899028708   4052899011335   4052899197404	No declarable substances contained
SIRIUS HRI 140 W RO	Усиленный	6000 hr	4052899258969   4052899224056	No declarable substances contained
SIRIUS HRI 190 W+		3000 hr	4052899475397   4008321866592	No declarable substances contained
SIRIUS HRI 230 W	Усиленный	2500 hr	4008321810311	No declarable substances contained
SIRIUS HRI 231 W		2000 hr	4062172128681   4062172212311   4052899553521	No declarable substances contained



## Данные о продуктовой линейке

Описание продукта	Охлаждение	Срок службы	Нормативная и природоохранная информация Information according Art. 33 of EU Regulation (EC) 1907/2006 (REACH)	
		Average Rated Life	Основной идентификатор изделия	Номер декларации в базе данных SCIP
SIRIUS HRI 280 W	Усиленный	2000 hr	4008321810342	No declarable substances contained
SIRIUS HRI 251 W		3000 hr	4062172212458   4062172212434	No declarable substances contained
SIRIUS HRI 281 W		2000 hr	4052899553552   4062172128704	No declarable substances contained
SIRIUS HRI 260 W PRO		6000 hr	4062172118927   4062172118941	No declarable substances contained
SIRIUS HRI 330 W	Усиленный	1500 hr	4008321810373	No declarable substances contained
SIRIUS HRI 280 W RO		2000 hr	4052899110397	No declarable substances contained
SIRIUS HRI 330 W X8		1500 hr	4052899140325   4052899224346   4052899140295	No declarable substances contained
SIRIUS HRI 371 W +		3000 hr	4062172110327   4062172110341	No declarable substances contained
SIRIUS HRI 295 W		2500 hr	4062172283328   4062172283304	No declarable substances contained
SIRIUS HRI 310 W		2500 hr	4062172202169   4062172202183	No declarable substances contained
SIRIUS HRI 310 W RO		3000 hr	4062172140867   4062172140843	No declarable substances contained
HRI 371 W S +		3000 hr	4062172110372   4062172110396	No declarable substances contained
SIRIUS HRI 371 W		1500 hr	4062172057004   4062172056984	No declarable substances contained
SIRIUS HRI 310 W PRO		1500 hr	4062172169424   4062172085304	No declarable substances contained
SIRIUS HRI 371 W S		1500 hr	4062172056939   4062172056953	No declarable substances contained
SIRIUS HRI 310 W S PRO		1500 hr	4062172169455   4062172122825	No declarable substances contained
SIRIUS HRI 440 W	Усиленный	1500 hr	4052899259096   4052899222212   4052899587892   4052899570566   4052899553644	No declarable substances contained
SIRIUS HRI 311 W		2500 hr	4062172169363	No declarable substances contained
SIRIUS HRI 440 W H		1000 hr	4052899576735	No declarable substances contained
SIRIUS HRI 330 W XL		1500 hr	4052899195431	No declarable substances contained
SIRIUS HRI 471 W SN		1500 hr	4062172040358	No declarable substances contained

## Данные о продуктовой линейке

Описание продукта	Охлаждение	Срок службы	Нормативная и природоохранная информация Information according Art. 33 of EU Regulation (EC) 1907/2006 (REACH)	
		Average Rated Life	Основной идентификатор изделия	Номер декларации в базе данных SCIP
SIRIUS HRI 550 W XL		1000 hr	4062172168212   4062172168236	No declarable substances contained
SIRIUS HRI 381 W S		2500 hr	4062172226240   4062172226226	No declarable substances contained
SIRIUS HRI 380 W Pro		2500 hr	4062172168601   4062172168625	No declarable substances contained
SIRIUS HRI 380 W S PRO		2500 hr	4062172168311   4062172168335	No declarable substances contained
SIRIUS HRI 382 W		2500 hr	4062172047135   4062172326131	No declarable substances contained
SIRIUS HRI 382 W S		1500 hr	4062172033541   4062172326100	No declarable substances contained
SIRIUS HRI 420 W		2500 hr	4062172192750   4062172192736	No declarable substances contained
SIRIUS HRI 420 W S		2500 hr	4062172192682   4062172392938   4062172393225   4062172192705   4062172392891   4062172393201	No declarable substances contained
SIRIUS HRI 440 W +		1500 hr	4062172348874   4062172047333	No declarable substances contained
SIRIUS HRI 440 W S		1000 hr	4052899329140	No declarable substances contained
SIRIUS HRI 440 W X		1500 hr	4062172017442	No declarable substances contained
SIRIUS HRI 461 W		1500 hr	4052899553613	No declarable substances contained
SIRIUS HRI 461 W S		1500 hr	4052899553583	No declarable substances contained
SIRIUS HRI 462 W		2000 hr	4062172302128   4062172302104	No declarable substances contained
SIRIUS HRI 470 W		1500 hr	4062172169332   4052899580961	No declarable substances contained
SIRIUS HRI 470 W S		1500 hr	4052899580985   4062172169301	No declarable substances contained
SIRIUS HRI 470 W RO		1500 hr	4052899477018	No declarable substances contained
SIRIUS HRI 470 W XL		1500 hr	4062172017473   4062172168281	No declarable substances contained
SIRIUS HRI 550 W		1500 hr	4062172008761   4062172078122	No declarable substances contained
HRI 580 W F		1000 hr	4062172085267	No declarable substances contained

## Данные о продуктовой линейке

Описание продукта	Список компонентов вещества 1
SIRIUS HRI 100 W	No declarable substances contained
SIRIUS HRI 132 W SC	No declarable substances contained
SIRIUS HRI 140 W RO	No declarable substances contained
SIRIUS HRI 190 W+	No declarable substances contained
SIRIUS HRI 230 W	No declarable substances contained
SIRIUS HRI 231 W	No declarable substances contained
SIRIUS HRI 280 W	No declarable substances contained
SIRIUS HRI 251 W	No declarable substances contained
SIRIUS HRI 281 W	No declarable substances contained
SIRIUS HRI 260 W PRO	No declarable substances contained
SIRIUS HRI 330 W	No declarable substances contained
SIRIUS HRI 280 W RO	No declarable substances contained
SIRIUS HRI 330 W X8	No declarable substances contained
SIRIUS HRI 371 W +	No declarable substances contained
SIRIUS HRI 295 W	No declarable substances contained
SIRIUS HRI 310 W	No declarable substances contained
SIRIUS HRI 310 W RO	No declarable substances contained
HRI 371 W S +	No declarable substances contained
SIRIUS HRI 371 W	No declarable substances contained
SIRIUS HRI 310 W PRO	No declarable substances contained
SIRIUS HRI 371 W S	No declarable substances contained
SIRIUS HRI 310 W S PRO	No declarable substances contained
SIRIUS HRI 440 W	No declarable substances contained
SIRIUS HRI 311 W	No declarable substances contained

## Данные о продуктовой линейке

Описание продукта	Список компонентов вещества 1
SIRIUS HRI 440 W H	No declarable substances contained
SIRIUS HRI 330 W XL	No declarable substances contained
SIRIUS HRI 471 W SN	No declarable substances contained
SIRIUS HRI 550 W XL	No declarable substances contained
SIRIUS HRI 381 W S	No declarable substances contained
SIRIUS HRI 380 W Pro	No declarable substances contained
SIRIUS HRI 380 W S PRO	No declarable substances contained
SIRIUS HRI 382 W	No declarable substances contained
SIRIUS HRI 382 W S	No declarable substances contained
SIRIUS HRI 420 W	No declarable substances contained
SIRIUS HRI 420 W S	No declarable substances contained
SIRIUS HRI 440 W +	No declarable substances contained
SIRIUS HRI 440 W S	No declarable substances contained
SIRIUS HRI 440 W X	No declarable substances contained
SIRIUS HRI 461 W	No declarable substances contained
SIRIUS HRI 461 W S	No declarable substances contained
SIRIUS HRI 462 W	No declarable substances contained
SIRIUS HRI 470 W	No declarable substances contained
SIRIUS HRI 470 W S	No declarable substances contained
SIRIUS HRI 470 W RO	No declarable substances contained
SIRIUS HRI 470 W XL	No declarable substances contained
SIRIUS HRI 550 W	No declarable substances contained
HRI 580 W F	No declarable substances contained

## Данные о продуктовой линейке

---

### Советы по безопасности

Из-за высокой яркости, ультрафиолетового излучения и высокого внутреннего давления лампы SIRIUS HRI могут использоваться только в закрытых корпусах, специально предназначенных для этой цели. Правильно подобранные фильтры позволяют снизить уровень УФ-излучения до приемлемого уровня. Из треснувшей лампы может выделяться ртуть: необходимо соблюдать особые меры предосторожности. Инструкция по безопасному обращению с лампами предоставляется по запросу и приведена в прилагаемой к лампам брошюре и руководстве пользователя.

### Рекомендации по применению

Для получения дополнительной информации и изображения продукции, пожалуйста, ознакомьтесь с инструкцией.

### Примечание

В заказ могут быть внесены изменения без предварительного уведомления. Проверьте информацию на наличие ошибок. Убедитесь, что информация актуальна.